

**BURAK IŞILAK**

**Operations,  
Themes and  
Relations of Voids**

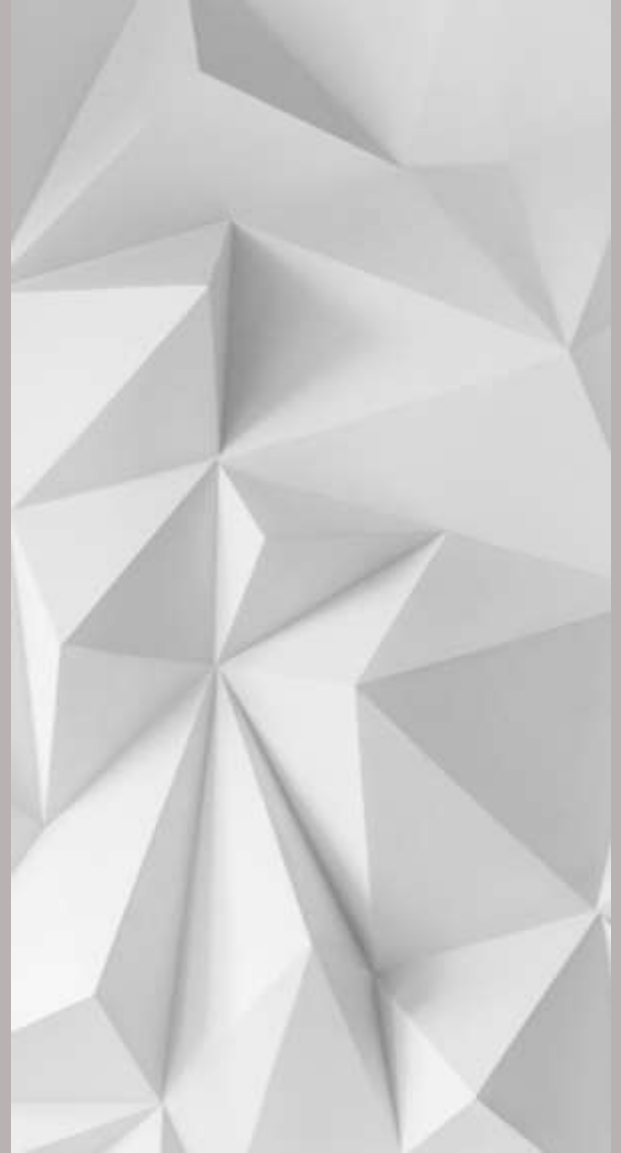

**ARCH101**

# UNIT 1

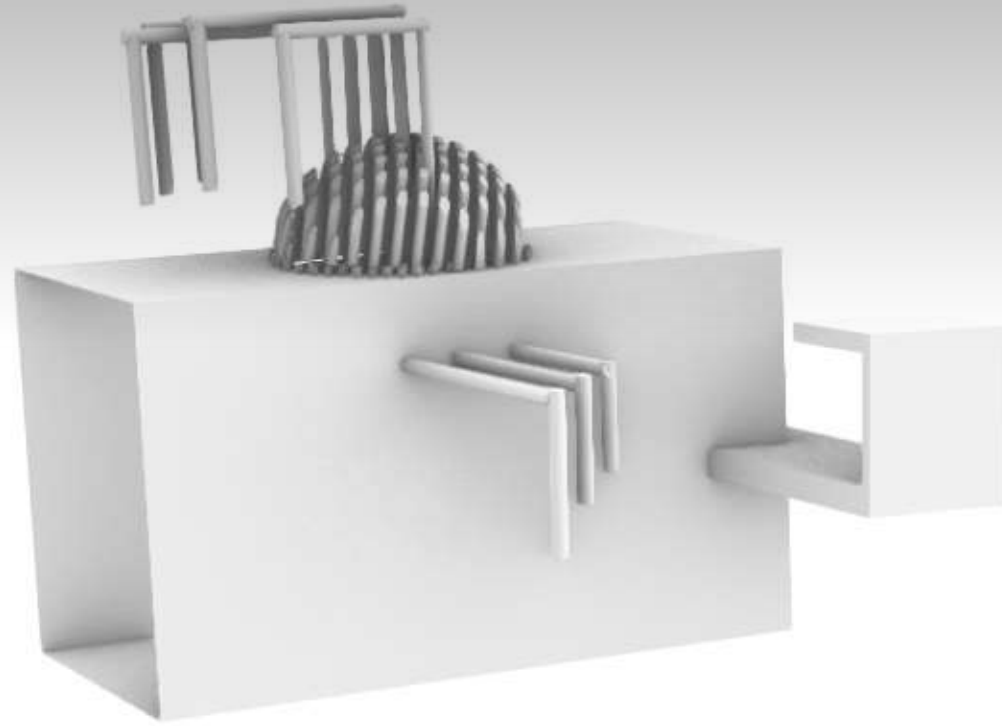

# UNIT 2

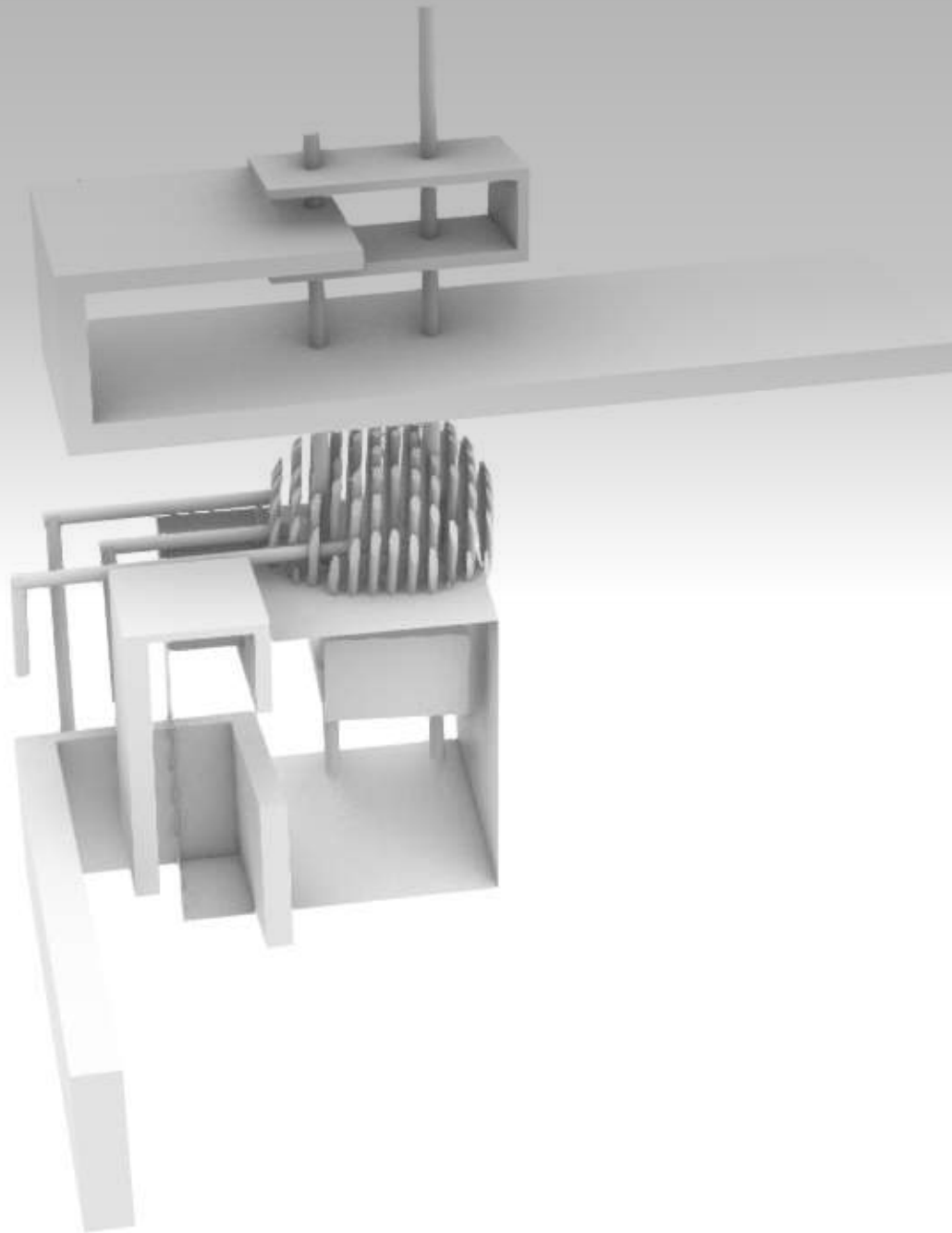

# GROUP

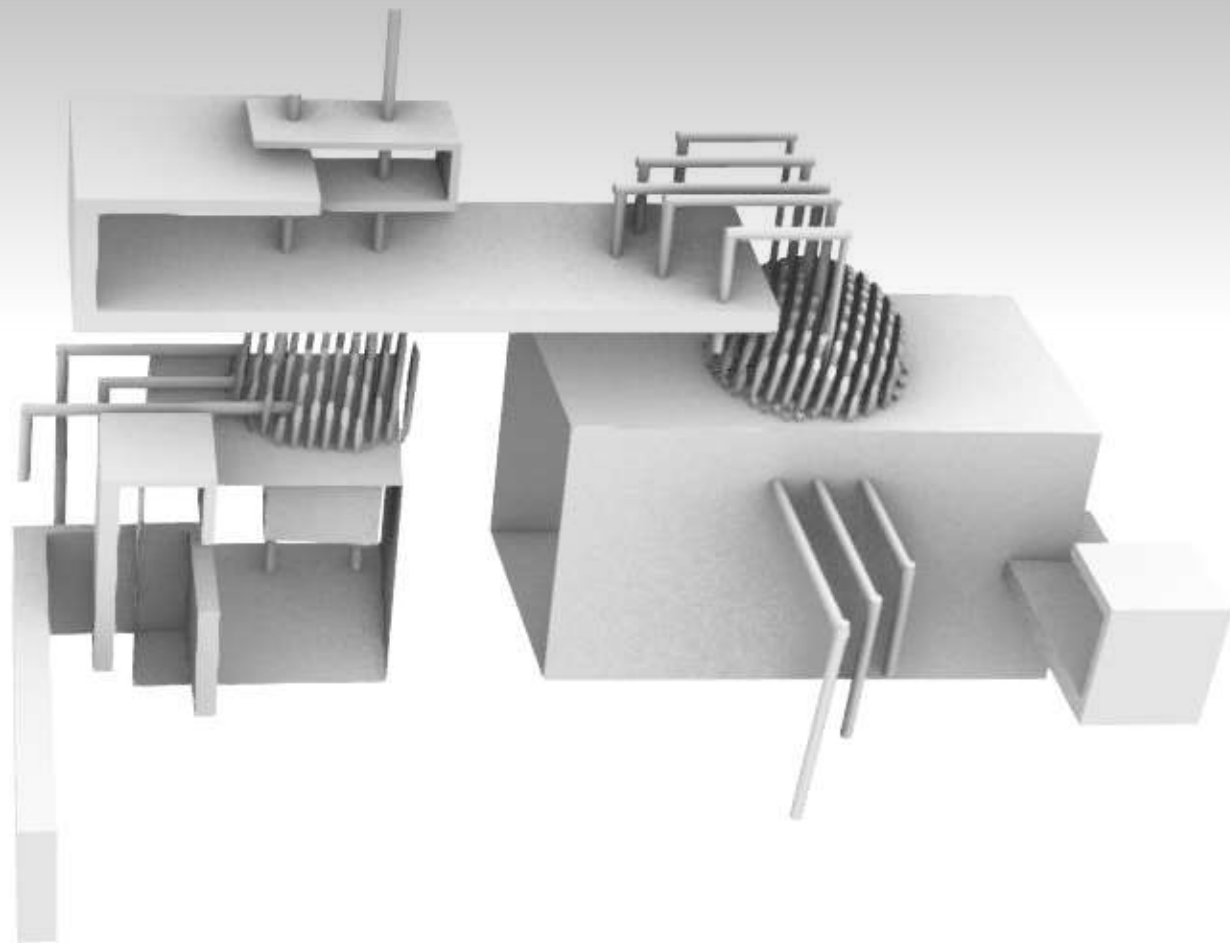

# WHOLE COMPOSITION

**Open-closed**  
**Fragmented**

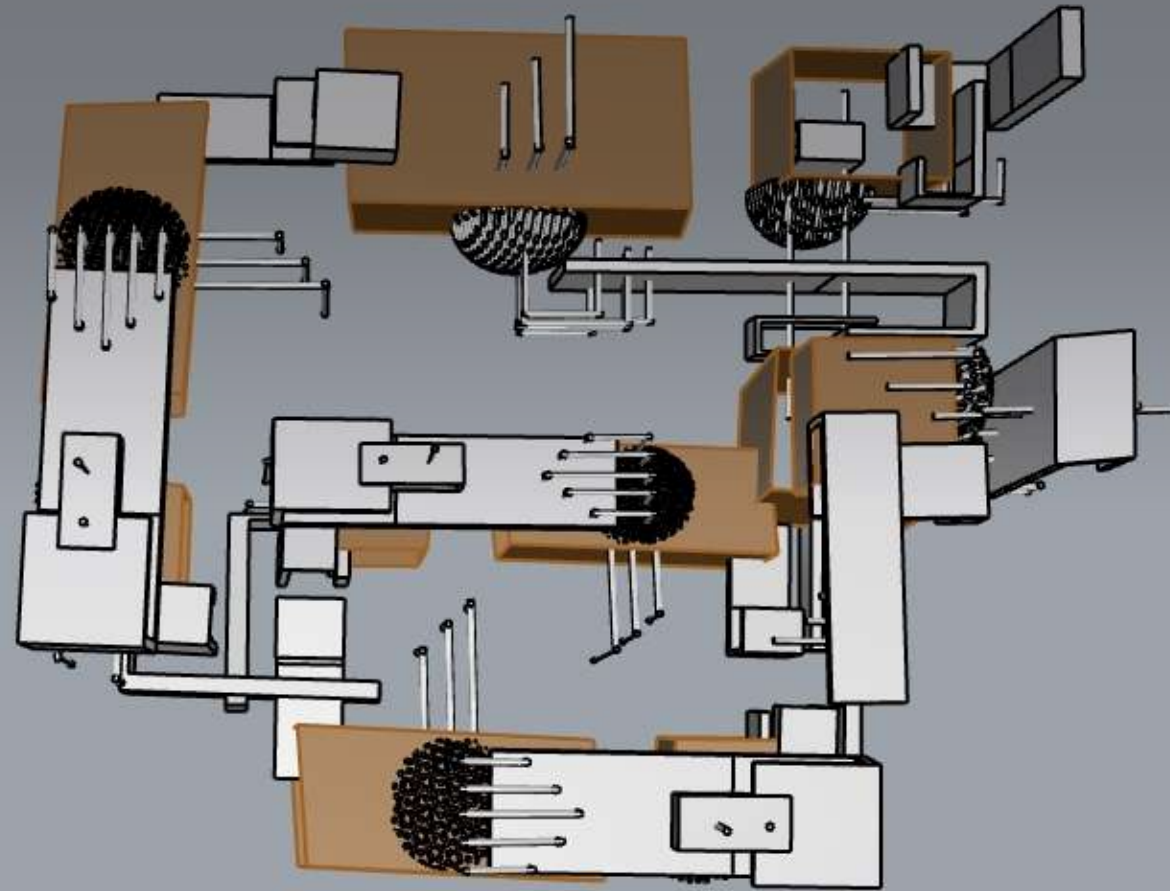

# CROSS SECTIONS

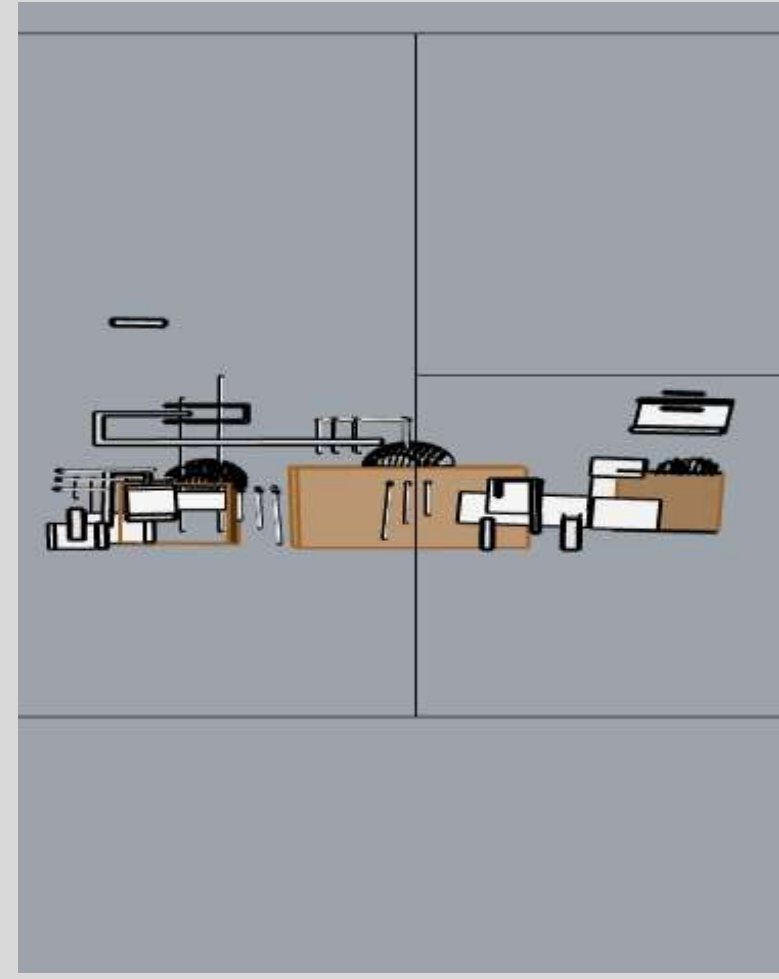
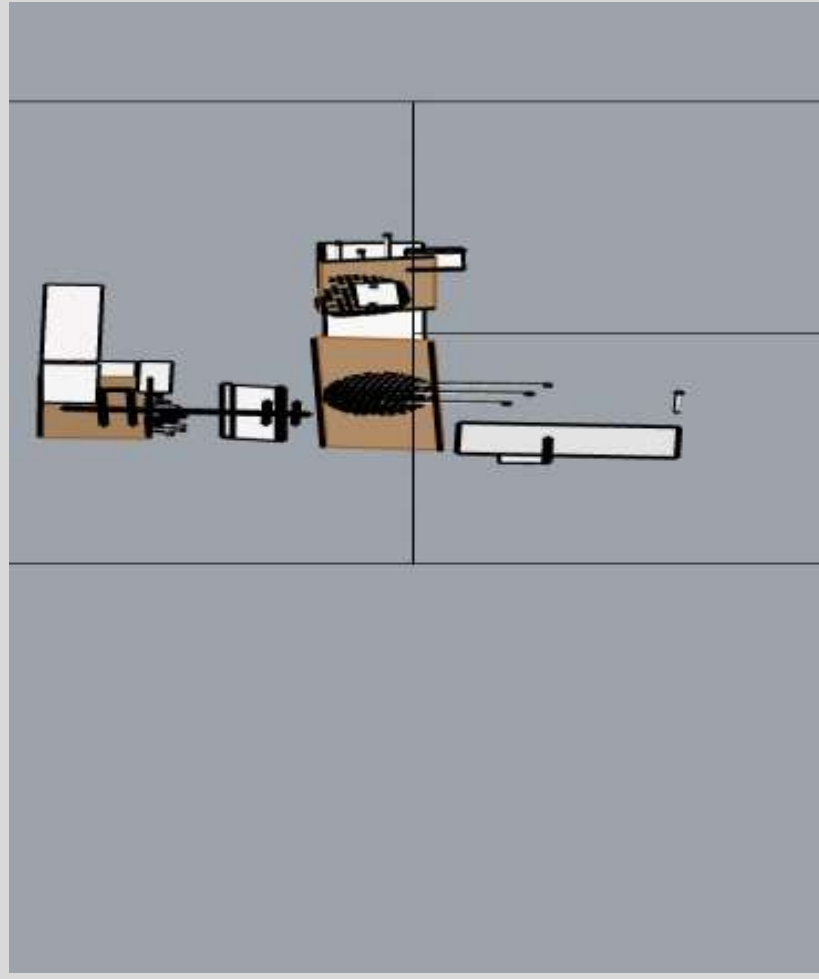
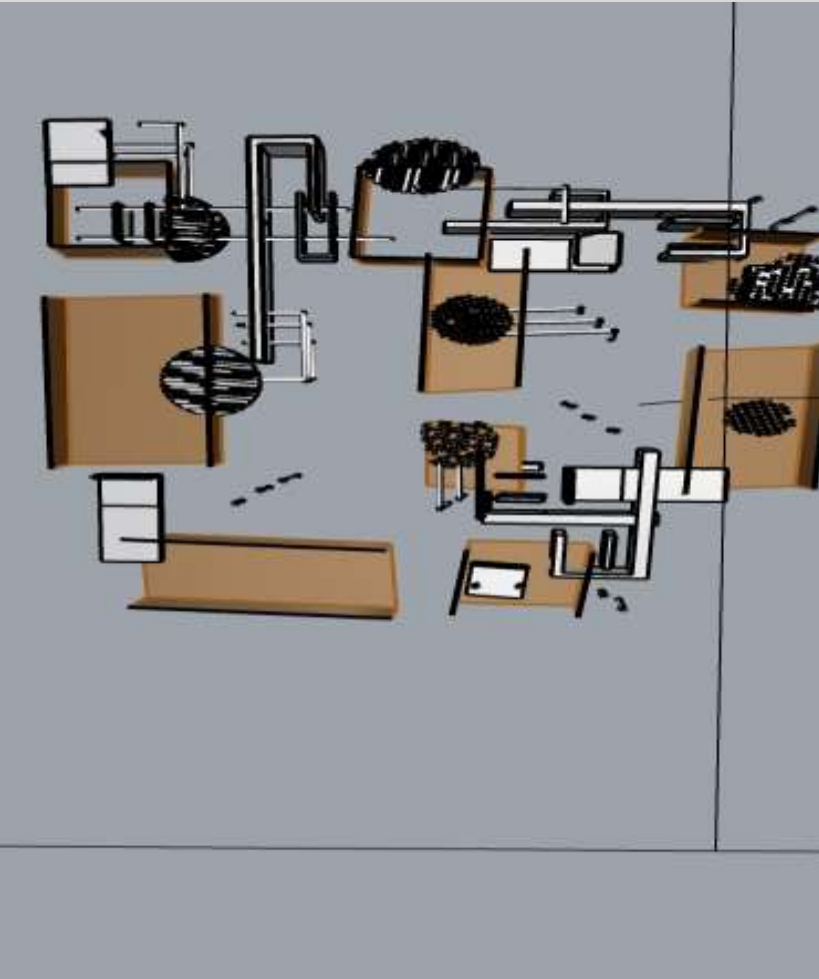

# OPERATION 1

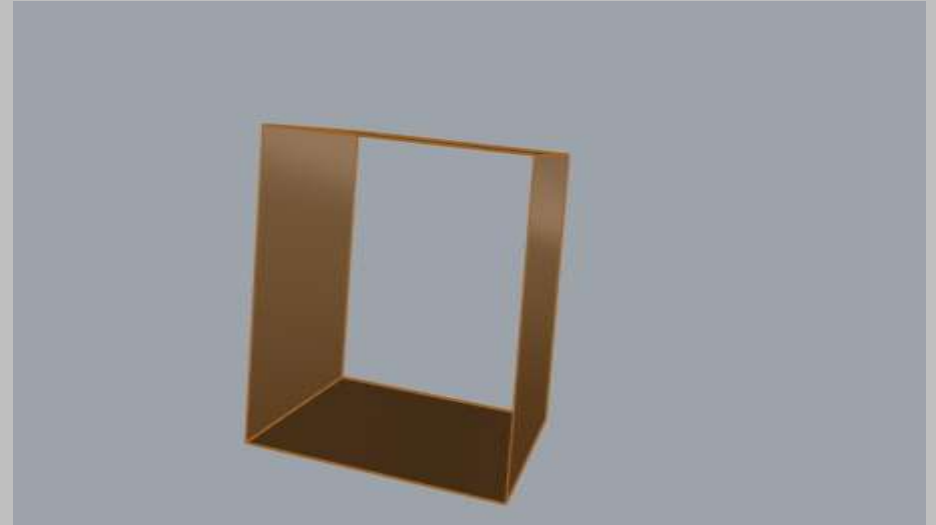
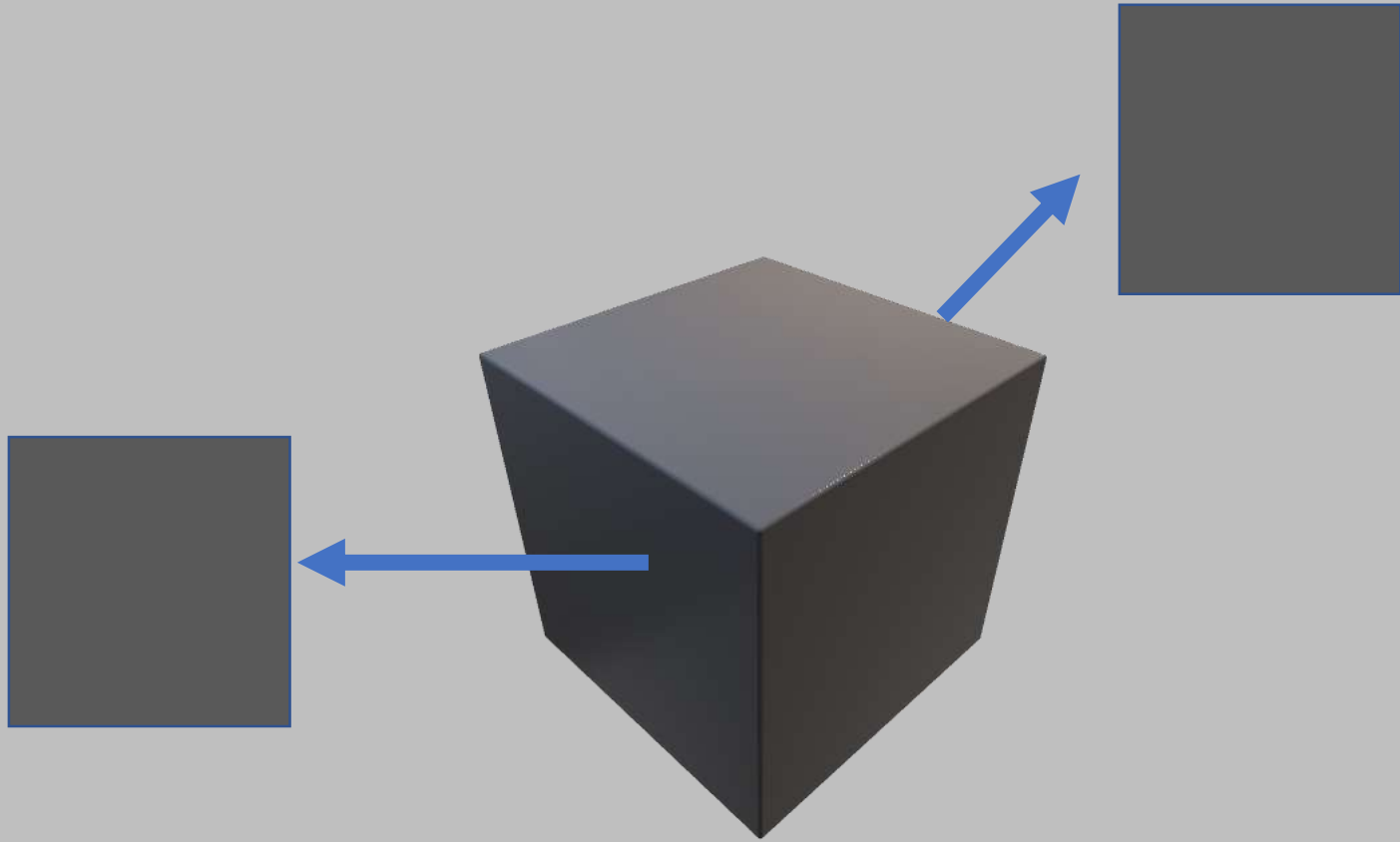

# OPERATION 2

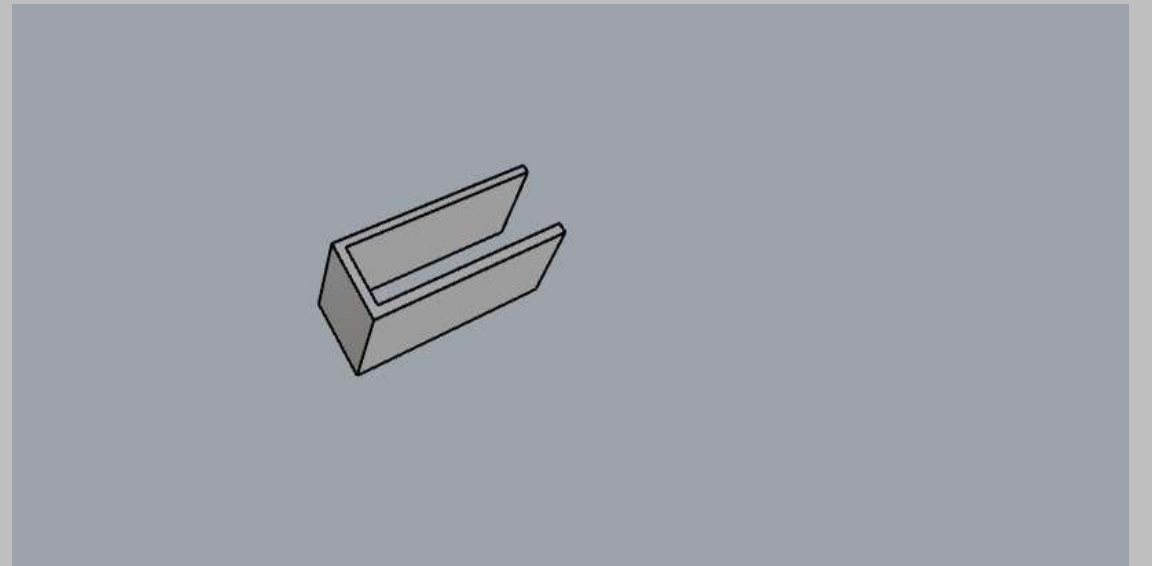
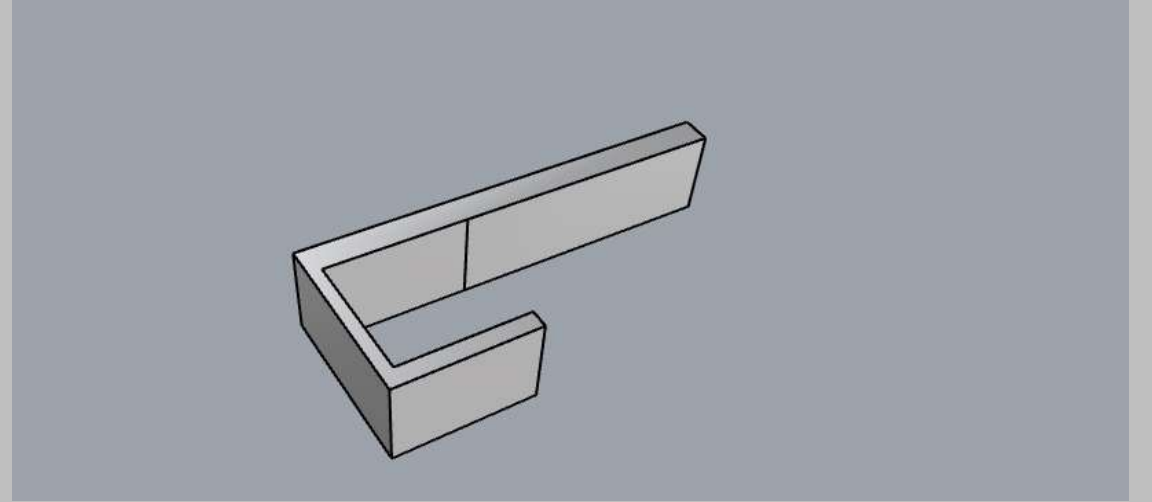
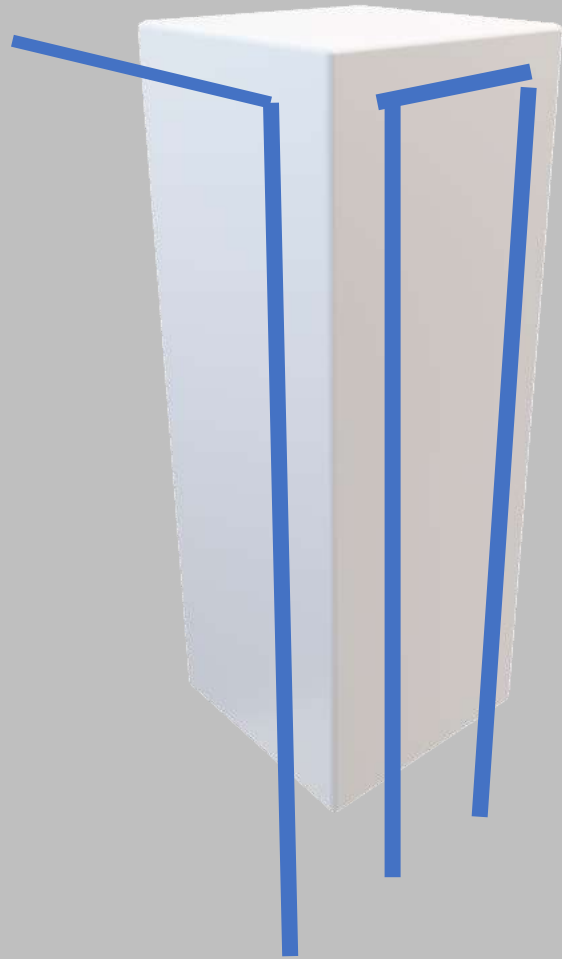



# OPERATION 3

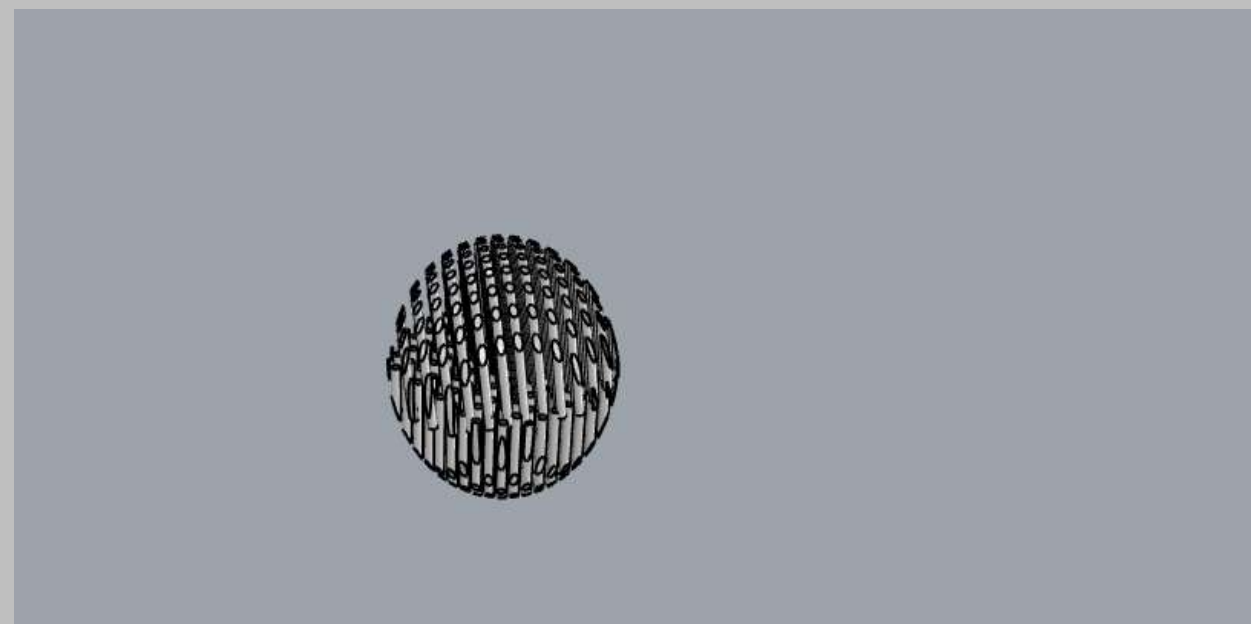
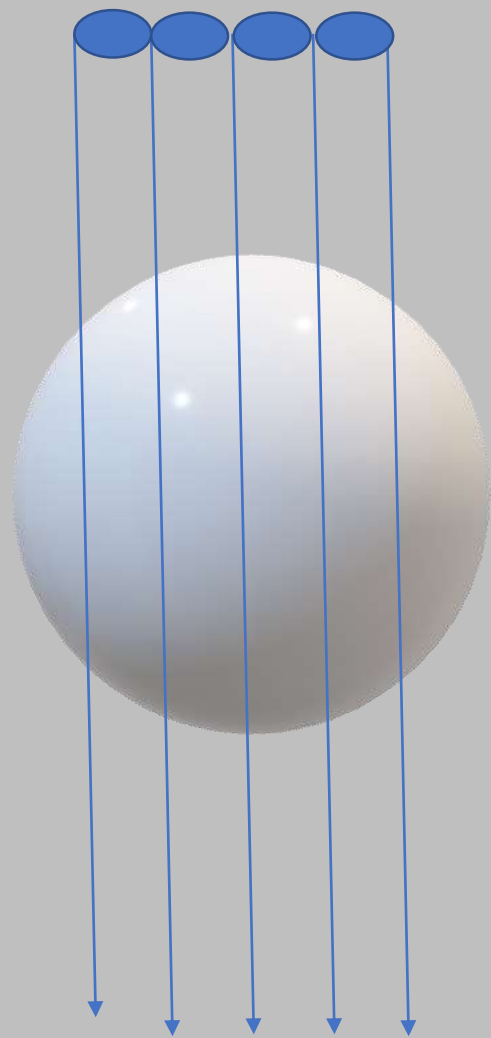

# DIAGRAM

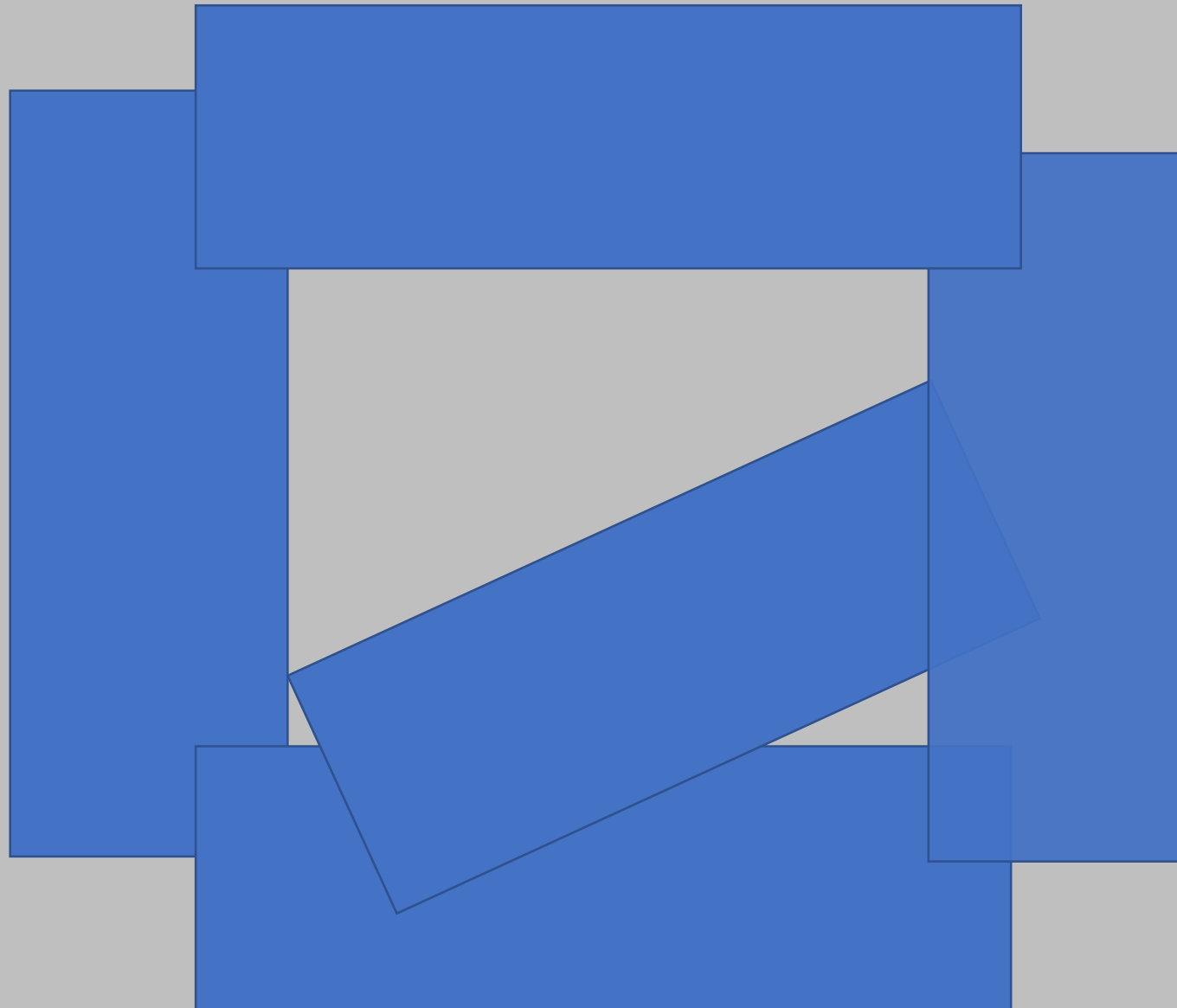

 : GROUP